

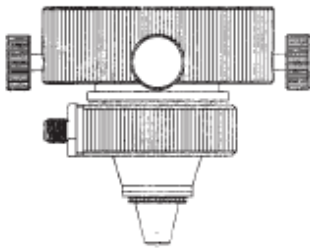









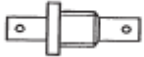







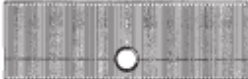







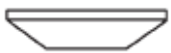

**Consumables suitable for
 Mazak® Super Charge XT510 HI-PRO, NTX48**

		Complete nozzle holder.....
46683301980		Connecting cable for sensor head.....
46683301400		Cable adapter.....
46683301230		Plate.....
46683301110		Bracket.....
46683301080		Teflon spacer 27 x 5,5.....
46603350001		O-Ring Ø 31 x 2.....
46683301070		Base.....
46683301090		Teflon spacer 30 x 4.....
46603300032		Screw M5 x 0,5.....
46683300930		Ring.....
46683301100		Bracket.....
46683301120		Teflon spacer 24 x 3.....
46683300850		Nozzle holder.....
46683301130		Teflon spacer 24 x 4.....
46683301140		Housing.....



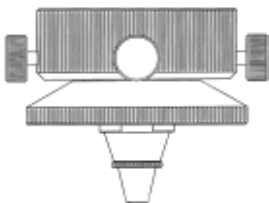

46683301170		Connector.....
46683300000		Screw M2,5 x 4.....
46683301850		Teflon fastener.....
46683301860		Cable holder.....
46683301870		Cover.....
46683301150		Teflon spacer 17 x 1,5.....
46683301930		Teflon spacer.....
46683301160		Ring.....

**Consumables suitable for Mazak® Laser
Turbo 10 kW, Super Turbo 15 kW
and Super Turbo Hi-Pro 20 kW**

		Complete nozzle holder.....
46603300032		Screw M5 x 0,5.....
46603350002		Ring.....
46603350001		O-Ring Ø 31 x 2.....
46523300080		Base.....



		O-Ring Ø 22 x 1,5.....
46603350510		Nozzle-adapter.....
46683300030		Retainer.....

**Consumables suitable for Mazak® Laser
 with CNC L32 Plus Super Charge
 XT510 and new: NTX48**

Standard copper nozzles

46683301950-8		Nozzle Ø 0,8 mm.....
46683301950-10		Nozzle Ø 1,0 mm.....
46683301950-12		Nozzle Ø 1,2 mm.....
46683301950		Nozzle Ø 1,5 mm.....
46683301821		Nozzle Ø 2,0 mm.....
46683301821-22		Nozzle Ø 2,2 mm.....
46683301960		Nozzle Ø 2,5 mm.....
46683301970		Nozzle Ø 3,0 mm.....
		Nozzle Ø 3,5 mm.....
	Nozzle Ø 4,0 mm.....	

Chromium plated nozzles

46683301950-8		Nozzle Ø 0,8 mm chromium plated
46683301950-10		Nozzle Ø 1,0 mm chromium plated
46683301950-12		Nozzle Ø 1,2 mm chromium plated
46683301950		Nozzle Ø 1,5 mm chromium plated
46683301821		Nozzle Ø 2,0 mm chromium plated
46683301821-22		Nozzle Ø 2,2 mm chromium plated
46683301960		Nozzle Ø 2,5 mm chromium plated
46683301970		Nozzle Ø 3,0 mm chromium plated
		Nozzle Ø 3,5 mm chromium plated
	Nozzle Ø 4,0 mm chromium plated	



Standard copper nozzles



- Double-Nozzle Ø 1,0 mm.....
- Double-Nozzle Ø 1,2 mm.....
- Double-Nozzle Ø 1,5 mm.....
- Double-Nozzle Ø 2,0 mm.....
- Double-Nozzle Ø 2,2 mm.....
- Double-Nozzle Ø 2,5 mm.....
- Double-Nozzle Ø 3,0 mm.....

Chromium plated nozzles



- Double-Nozzle Ø 1,0 mm **chromium plated..**
- Double-Nozzle Ø 1,2 mm **chromium plated..**
- Double-Nozzle Ø 1,5 mm **chromium plated..**
- Double-Nozzle Ø 2,0 mm **chromium plated..**
- Double-Nozzle Ø 2,2 mm **chromium plated..**
- Double-Nozzle Ø 2,5 mm **chromium plated..**
- Double-Nozzle Ø 3,0 mm **chromium plated..**

**Consumables suitable for Mazak® Turbo 10 kW,
 Super Turbo 15 kW, Super Turbo Hi-Pro 20 kW
 and Super Turbo X510 HI-PRO**

Standard copper nozzles

- 46603350508
- 46603350511
- 46603350512
- 46603350515
- 46603350517
- 46603350520
- 46603350525
- 46603350530
- 46603350535
- 46603350540



- Adapter nozzle Ø 0,8 mm.....
- Adapter nozzle Ø 1,0 mm.....
- Adapter nozzle Ø 1,2 mm.....
- Adapter nozzle Ø 1,5 mm.....
- Adapter nozzle Ø 1,7 mm.....
- Adapter nozzle Ø 2,0 mm.....
- Adapter nozzle Ø 2,5 mm.....
- Adapter nozzle Ø 3,0 mm.....
- Adapter nozzle Ø 3,5 mm.....
- Adapter nozzle Ø 4,0 mm.....

- 46603350508
- 46603350511
- 46603350512
- 46603350515
- 46603350517
- 46603350520
- 46603350525
- 46603350530



- Adapter-6-edgenozzle Ø 0,8 mm.....
- Adapter-6-edgenozzle Ø 1,0 mm.....
- Adapter-6-edgenozzle Ø 1,2 mm.....
- Adapter-6-edgenozzle Ø 1,5 mm.....
- Adapter-6-edgenozzle Ø 1,7 mm.....
- Adapter-6-edgenozzle Ø 2,0 mm.....
- Adapter-6-edgenozzle Ø 2,5 mm.....
- Adapter-6-edgenozzle Ø 3,0 mm.....



Nozzles with hard chromium plating

46603350508
46603350511
46603350512
46603350515
46603350517
46603350520
46603350525
46603350530
46603350535
46603350540



Adapter nozzle Ø 0,8 mm **Hard chromium plating...**
Adapter nozzle Ø 1,0 mm **Hard chromium plating...**
Adapter nozzle Ø 1,2 mm **Hard chromium plating...**
Adapter nozzle Ø 1,5 mm **Hard chromium plating...**
Adapter nozzle Ø 1,7 mm **Hard chromium plating...**
Adapter nozzle Ø 2,0 mm **Hard chromium plating...**
Adapter nozzle Ø 2,5 mm **Hard chromium plating...**
Adapter nozzle Ø 3,0 mm **Hard chromium plating...**
Adapter nozzle Ø 3,5 mm **Hard chromium plating...**
Adapter nozzle Ø 4,0 mm **Hard chromium plating...**

46603350508
46603350511
46603350512
46603350515
46603350517
46603350520
46603350525
46603350530



Adapter-6-edgenozzle Ø 0,8 mm **Hard chromium pl.**
Adapter-6-edgenozzle Ø 1,0 mm **Hard chromium pl.**
Adapter-6-edgenozzle Ø 1,2 mm **Hard chromium pl.**
Adapter-6-edgenozzle Ø 1,5 mm **Hard chromium pl.**
Adapter-6-edgenozzle Ø 1,7 mm **Hard chromium pl.**
Adapter-6-edgenozzle Ø 2,0 mm **Hard chromium pl.**
Adapter-6-edgenozzle Ø 2,5 mm **Hard chromium pl.**
Adapter-6-edgenozzle Ø 3,0 mm **Hard chromium pl.**

**Consumables suitable for
Mazak® and Precitec® 5" C/MG
5" H/MG**

4671330032



Ring for SPACE GEAR Vespele®.....

Nozzles are packed in strips of 10 tear-off bags

281006
281030
281031
280898



Nozzle Ø 1,0 mm kk (P0352-333-00010).....
Nozzle Ø 1,2 mm kk (P0352-334-00012).....
Nozzle Ø 1,5 mm kk (P0352-335-00015).....
Nozzle Ø 1,8 mm kk (P0352-336-00018).....
Nozzle Ø 2,0 mm kk

281005
281034
281013
280899
350044-3



Nozzle Ø 1,0 mm zk (P0352-323-00010).....
Nozzle Ø 1,2 mm zk (P0352-324-00012).....
Nozzle Ø 1,5 mm zk (P0352-325-00015).....
Nozzle Ø 1,8 mm zk (P0352-326-00018).....
Nozzle Ø 2,0 mm zk (P0352-327-00020).....



- Nozzle Ø 1,0 mm 3D (P0352-383-00010).....
- Nozzle Ø 1,2 mm 3D (P0352-384-00012).....
- Nozzle Ø 1,5 mm 3D (P0352-381-00015).....
- Nozzle Ø 1,8 mm 3D.....
- Nozzle Ø 2,0 mm 3D (P0352-382-00020).....
- Nozzle Ø 2,5 mm 3D (P0352-385-00025).....
- Nozzle Ø 3,0 mm 3D.....



- Nozzle Ø 1,0 mm 2D.....
- Nozzle Ø 1,2 mm 2D.....
- Nozzle Ø 1,5 mm 2D (P0352-386-00015).....
- Nozzle Ø 1,8 mm 2D.....
- Nozzle Ø 2,0 mm 2D (P0352-387-00020).....
- Nozzle Ø 2,5 mm 2D.....
- Nozzle Ø 3,0 mm 2D.....

**Consumables suitable for
 Mazak® HyperGear NTX510®**

Nozzles with hard chromium plating

- 46143304440
- 46143304450
- 46143304460
- 46143304480
- 46143304490
- 46143304500
- 46143304510



- Nozzle Ø 1,0 mm **Hard chromium plating**.....
- Nozzle Ø 1,2 mm **Hard chromium plating**.....
- Nozzle Ø 1,5 mm **Hard chromium plating**.....
- Nozzle Ø 2,0 mm **Hard chromium plating**.....
- Nozzle Ø 2,5 mm **Hard chromium plating**.....
- Nozzle Ø 3,0 mm **Hard chromium plating**.....
- Nozzle Ø 3,5 mm **Hard chromium plating**.....
- Nozzle Ø 4,0 mm **Hard chromium plating**.....



- Double nozzle Ø 1,2 mm **Hard chromium plating**...
- Double nozzle Ø 1,5 mm **Hard chromium plating**...
- Double nozzle Ø 2,0 mm **Hard chromium plating**...
- Double nozzle Ø 2,5 mm **Hard chromium plating**...
- Double nozzle Ø 3,0 mm **Hard chromium plating**...
- Double nozzle Ø 3,5 mm **Hard chromium plating**...
- Double nozzle Ø 4,0 mm **Hard chromium plating**...